

Accessori e ricambi

Accessories and spare parts



Smontaconi
Tool assembly device

p. 310

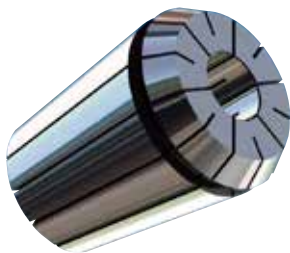

Pinze
Collets

p. 312



Ghiere
Locknuts

p. 336

p. 342

Chiavi di serraggio Wrenches for nuts



p. 346

Bussole portamaschi Tap-collets

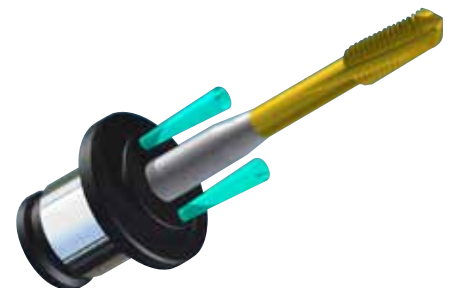

Dati tecnici ed immagini sono indicativi. Mickros si riserva di apportare aggiornamenti in qualsiasi momento e senza obbligo di preavviso.
Technical data and drawings are for information purposes only. Mickros reserves the right to update specs at anytime and without notice.

Smontaconi con Gabbia a Rulli

Tool assembly device roller Clamping



ATTREZZO PER IL MONTAGGIO/SMONTAGGIO DEI MANDRINI

- Inclinazione 90°
- Speciale gabbia a rulli bidirezionale
- Bloccaggio del portautensili sulla flangia
- Massima protezione del cono mandrino

TOOL ASSEMBLY DEVICE

- 90° Angle
- Special bidirectional roller-bearing
- Clamp the toolholders on the flange
- Max protection of the taper shank

ASC

codice - code	APPLICATION
ASC.BT30	BT30
ASC.HK032	HSK 32-PSC C3
ASC.HK040	HSK 40-PSC C4
ASC.HK50.IS030	HSK 50-ISO 30-PSC C5
ASC.HK63.BT40	HSK 63-BT 40-PSC C6
ASC.063.S90	HSK 63-SK 40-BT 40-PSC C6
ASC.097.S90	SK 50
ASC.100.BT50	HSK 100-BT 50

Smontaconi a doppia posizione

Tool assembly device double position

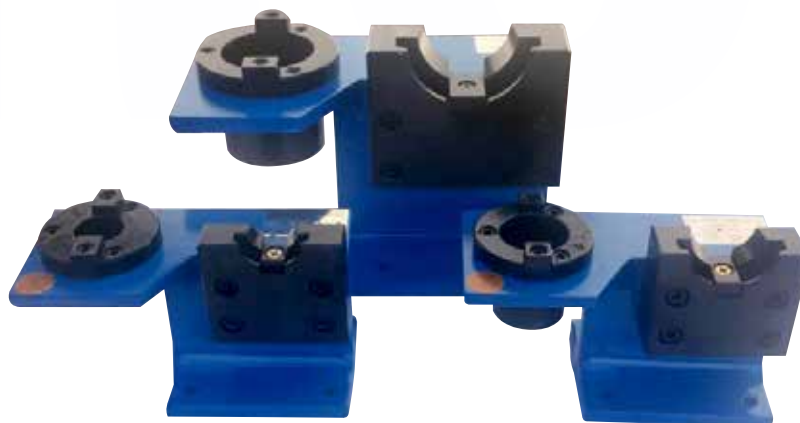

SMONTA MANDRINO VERTICALE E ORIZZONTALE per SK 40 - 50 e BT 30 - 40 - 50

- Pratico attrezzo per bloccare i mandrini da attrezzare per le macchine CNC
- ASD... SK - BT

CNC TOOL ASSEMBLY DEVICE VERTICAL AND HORIZONTAL for SK 40 - 50 and BT 30 - 40 - 50

- Practical tool for locking chuck to equip CNC machinery
- ASD... SK - BT

ASC... SK - BT

codice - code	APPLICATION
ASD.SK040	SK - 40
ASD.SK050	SK - 50
ASD.BT030	BT - 30
ASD.BT040	BT - 40
ASD.BT050	BT - 50

PINZE COLLETS ISO 15488 (DIN 6499)

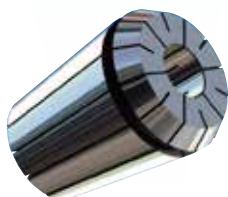

PER S - standard

Pinza standard DIN 6499
Standard collet DIN 6499

p. 317



PER S BOX

Box per pinze DIN 6499 standard
Collets DIN 6499 standard box

p. 320



PER S BAG

Valigetta per pinze DIN 6499 standard
Bag collets DIN 6499 standard

p. 321

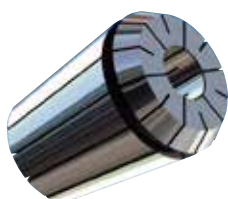

PER Q - high performance

Pinza DIN 6499 di alta qualità
High quality collet DIN 6499

p. 322



PER Q BAG

Valigetta per pinze DIN 6499 di alta qualità
Bag high quality collets DIN 6499

p. 325

PER T

Pinza a tenuta vulcanizzata DIN 6499

Rubber sealed collet DIN 6499

p. 326



PER TW

Pinze a tenuta con fori per refrigerante DIN 6499

Collets DIN 6499 externally cooled collets

p. 328



PER TSS

Pinze a tenuta meccanica DIN 6499

Solid sealed collets DIN 6499

p. 330

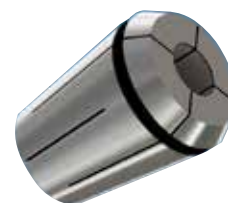

PER M

Pinza portamaschi DIN 6499-AZ

Collet tap holders DIN 6499-AZ

p. 332

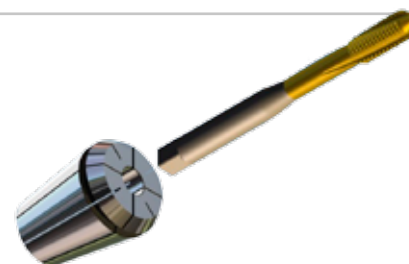

PER MT

Pinza DIN 6499 portamaschi con quadro a tenuta del refrigerante

Sealed tap collets DIN 6499 with internal square

p. 334

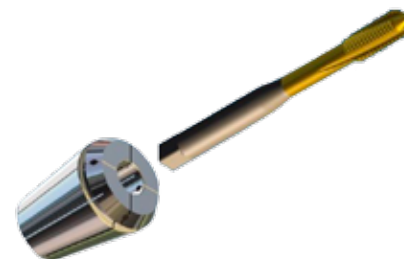

PINZE ISO 15488 (DIN 6499)

Collet DIN 6499

Pince de serrage DIN 6499

Spannzangen DIN 6499

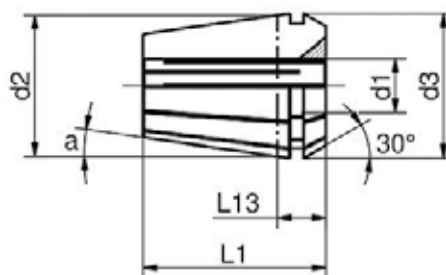
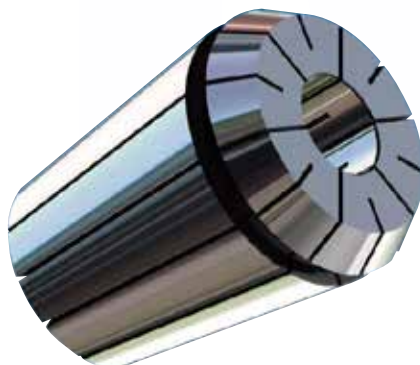

CARATTERISTICHE TECNICHE

- Costruite in acciaio 52 SiCrNi5 o equivalente
- Temprate e rinvenute HRC 45 + 2
- Rettificate di precisione esternamente ed internamente

TECNICAL FEATURES

- Produced in 52 SiCrNi5 steel or equivalent
- Tempered and hardened to HRC 45 + 2
- Precision ground internally and externally

codice - code	d1 mm min ÷ max	capacità di serraggio - gripping range	d 2	d 3	a	L1	L13 max	
PER11S	1 ÷ 7	1 ÷ 7	0.5 mm	11	11.5	8°	18	6.6
PER11Q								
PER16S	1 ÷ 10	1 ÷ 2,5	0.5 mm	16	17	8°	27.5	10.5
PER16Q		3 ÷ 10	1 mm					
PER20S	1 ÷ 13	1 ÷ 2,5	0.5 mm	20	21	8°	31.5	11.5
PER20Q		3 ÷ 13	1 mm					
PER25S	1 ÷ 16	1 ÷ 2,5	0.5 mm	25	26	8°	34	12
PER25Q		3 ÷ 16	1 mm					
PER32S	2 ÷ 20	2 ÷ 2,5	0.5 mm	32	33	8°	40	13
PER32Q		3 ÷ 20	1 mm					
PER40S	3 ÷ 26	3 ÷ 4	0.5 mm	40	41	8°	46	21
PER40Q		4 ÷ 26	1 mm					

Precisione di concentricità

Concentricity specification

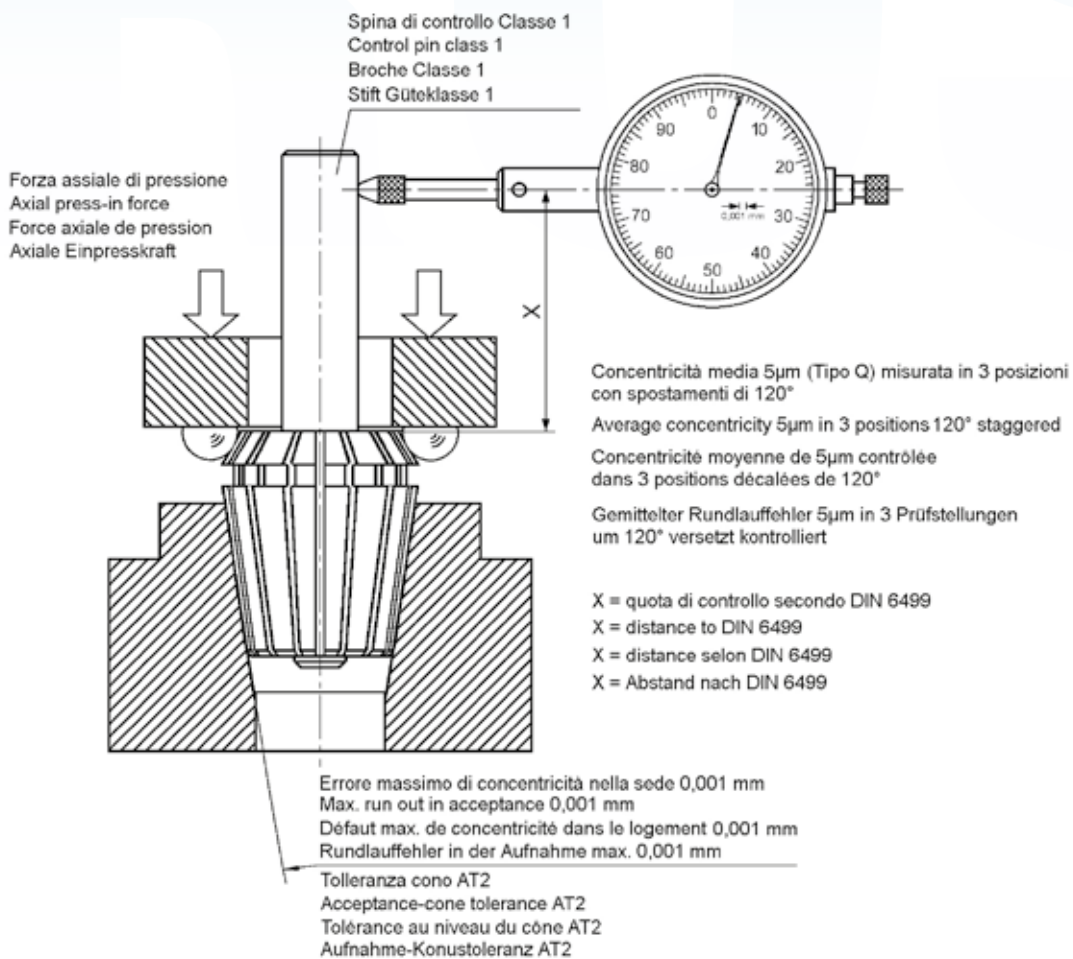

S = precisione standard - standard precision

Q = alta precisione - high precision

d 1=	d 1<	X	Run Out ↗ PER..S	Run Out ↗ PER..Q
1	1.5	6	0.015	0.005
1.6	3	10	0.015	0.005
3	7	16	0.015	0.005
7	10	25	0.015	0.005
10	18	40	0.020	0.005
18	26	50	0.020	0.005

MICK
KROS
CNC TOOL HOLDERS

PER S

Pinza standard DIN 6499

Standard collet DIN 6499

Pince de serrage standard DIN 6499

Standard spannzangen DIN 6499

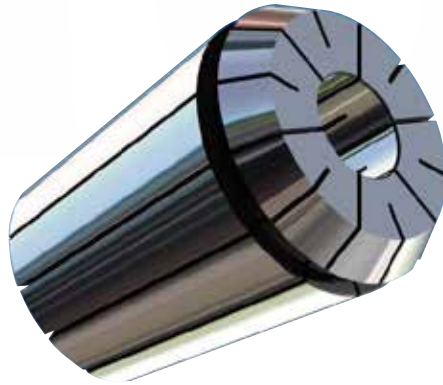

CARATTERISTICHE TECNICHE

- **Standard Precision**
RUN OUT 0,015 secondo DIN 6499
- Costruite in acciaio 52 SiCrNi5 o equivalente
- Temprate e rinvenute HRC 45+ 2
- Rettificate di precisione esternamente ed internamente

TECNICAL FEATURES

- *Standard Precision*
RUN OUT 0,015 according Din 6499
- *Produced in 52 SiCrNi5 steel or equivalent*
- *Tempered and hardened to HRC45+2*
- *Precision ground internally and externally*

S = precisione standard - standard precision

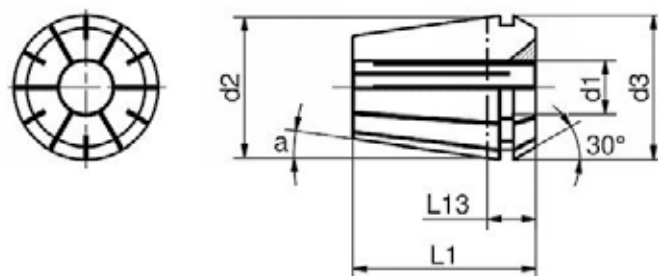

PER S

ER11 standard	
code	d 1
PER 11S 01	1
PER 11S 0150	1.5
PER 11S 02	2
PER 11S 0250	2.5
PER 11S 03	3
PER 11S 0350	3.5
PER 11S 04	4
PER 11S 0450	4.5
PER 11S 05	5
PER 11S 0550	5.5
PER 11S 06	6
PER 11S 0650	6.5
PER 11S 07	7

ER16 standard	
code	d 1
PER 16S 01	1
PER 16S 0150	1.5
PER 16S 02	2
PER 16S 0250	2.5
PER 16S 03	3
PER 16S 04	4
PER 16S 05	5
PER 16S 06	6
PER 16S 07	7
PER 16S 08	8
PER 16S 09	9
PER 16S 10	10

ER20 standard	
code	d 1
PER 20S 02	2
PER 20S 0250	2.5
PER 20S 03	3
PER 20S 04	4
PER 20S 05	5
PER 20S 06	6
PER 20S 07	7
PER 20S 08	8
PER 20S 09	9
PER 20S 10	10
PER 20S 11	11
PER 20S 12	12
PER 20S 13	13

S = precisione standard - standard precision

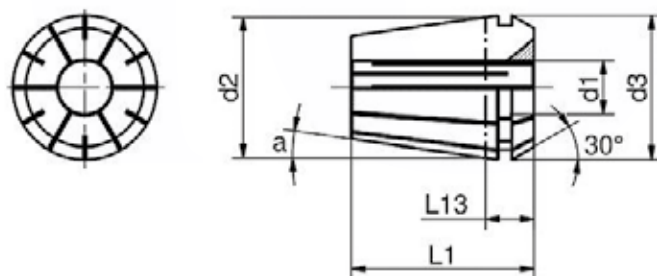

PER S

ER25 standard	
code	d 1
PER 25S 01	1
PER 25S 0150	1.5
PER 25S 02	2
PER 25S 0250	2.5
PER 25S 03	3
PER 25S 04	4
PER 25S 05	5
PER 25S 06	6
PER 25S 07	7
PER 25S 08	8
PER 25S 09	9
PER 25S 10	10
PER 25S 11	11
PER 25S 12	12
PER 25S 13	13
PER 25S 14	14
PER 25S 15	15
PER 25S 16	16

ER32 standard	
code	d 1
PER 32S 03	3
PER 32S 04	4
PER 32S 05	5
PER 32S 06	6
PER 32S 07	7
PER 32S 08	8
PER 32S 09	9
PER 32S 10	10
PER 32S 11	11
PER 32S 12	12
PER 32S 13	13
PER 32S 14	14
PER 32S 15	15
PER 32S 16	16
PER 32S 17	17
PER 32S 18	18
PER 32S 19	19
PER 32S 20	20

ER40 standard	
code	d 1
PER 40S 04	4
PER 40S 05	5
PER 40S 06	6
PER 40S 07	7
PER 40S 08	8
PER 40S 09	9
PER 40S 10	10
PER 40S 11	11
PER 40S 12	12
PER 40S 13	13
PER 40S 14	14
PER 40S 15	15
PER 40S 16	16
PER 40S 17	17
PER 40S 18	18
PER 40S 19	19
PER 40S 20	20
PER 40S 21	21
PER 40S 22	22
PER 40S 23	23
PER 40S 24	24
PER 40S 25	25
PER 40S 26	26

S = precisione standard - standard precision

PER S BOX

Box per pinze DIN 6499 Standard

Collets DIN 6499 standard box



Box per pinze DIN 6499 Standard

- Box con serie Pinze tipo ER DIN 6499 Standard
-
- Standard Precision RUN OUT 0,015 secondo DIN 6499

Collets DIN 6499 standard box

- Box with set of collets ER Type - Din 6499 Standard
-
- Standard Precision RUN OUT 0,015 according Din 6499

code	Ø 1	N° P.	APPLICATION
PER.11S.BOX13.P	1 ÷ 7 x 0,5	13	ER 11 - BOX
PER.16S.BOX10.P	1 ÷ 10 x 1,0	10	ER 16 - BOX
PER.20S.BOX12.P	2 ÷ 13 x 1,0	12	ER 20 - BOX
PER.25S.BOX15.P	2 ÷ 16 x 1,0	15	ER 25 - BOX
PER.32S.BOX.18P	3 ÷ 20 x 1,0	18	ER 32 - BOX
PER.40S.BOX23.P	4 ÷ 26 x 1,0	23	ER 40 - BOX

PER S BAG

Valigetta per pinze DIN 6499 standard

Bag collets DIN 6499 standard



Valigetta per pinze DIN 6499 standard

- Valigetta in Alluminio
con serie Pinze tipo - ER Din 6499 Standard
- Standard Precision
RUN OUT 0,015 secondo Din 6499

Bag collets DIN 6499 standard

- Aluminium Bag
with set of collets ER Type - Din 6499 Standard
- Standard Precision
RUN OUT 0,015 according Din 6499

code	Ø 1	N° P.	APPLICATION
PER.11S.BAG13.P	1 ÷ 7 x 0,5	13	ER11 - BAG
PER.16S.BAG10.P	1 ÷ 10 x 1,0	10	ER 16 - BAG
PER.20S.BAG12.P	2 ÷ 13 x 1,0	12	ER 20 - BAG
PER.25S.BAG15.P	2 ÷ 16 x 1,0	15	ER 25 - BAG
PER.32S.BAG18.P	3 ÷ 20 x 1,0	18	ER 32 - BAG
PER.40S.BAG23.P	4 ÷ 26 x 1,0	23	ER 40 - BAG

PER Q H/P High Performance

Pinza DIN 6499

Collet DIN 6499

Pince de serrage DIN 6499

Spannzangen DIN 6499

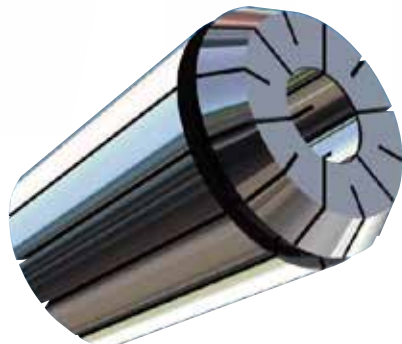

PINZE DI ALTA QUALITÀ Din 6499 **H/P High Performance**

- RUN OUT 5 micron
- Garanzia di una concentricità sempre elevata
- Elevata tenuta e rigidità
- Elevato fattore di portanza
- Notevole concentricità del sistema
- Alta resistenza alla corrosione
- Pinze portautensili con protezione anti-corrosione a livello micrometrico sulle aree funzionali
- La protezione anticorrosiva non è limitata solo alle aree visibili
- Intera gamma di prodotti con rivestimento delle aree funzionali nel range dei μm
- Protegge efficacemente da attacchi esterni
- Mantiene a lungo la funzionalità e la precisione

HIGH QUALITY COLLETS Din 6499 **H/P High Performance**

- *RUN OUT 5 micron*
- *To guarantee a consistent repeatable high accuracy*
- *Increased rigidity and clamping forces*
- *Improved grip*
- *Higher precision and system concentricity*
- *Enhanced resistance to corrosion*
- *Collets with anti-corrosion protection to micrometer level on functional areas*
- *The corrosion protection is not only limited to the visible areas*
- *Full range of products with a coating of the functional areas in the μ -range*
- *Protects against external attacks effectively*
- *Keeps long the functionality and accuracy*

Q = alta precisione - high precision

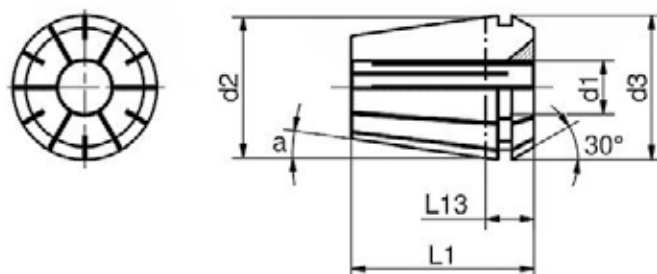

PER Q

ER11 precisa	
code	d 1
PER 11Q 01	1
PER 11Q 0150	1.5
PER 11Q 02	2
PER 11Q 0250	2.5
PER 11Q 03	3
PER 11Q 0350	3.5
PER 11Q 04	4
PER 11Q 0450	4.5
PER 11Q 05	5
PER 11Q 0550	5.5
PER 11Q 06	6
PER 11Q 0650	6.5
PER 11Q 07	7

ER16 precisa	
code	d 1
PER 16Q 01	1
PER 16Q 0150	1.5
PER 16Q 02	2
PER 16Q 0250	2.5
PER 16Q 03	3
PER 16Q 04	4
PER 16Q 05	5
PER 16Q 06	6
PER 16Q 07	7
PER 16Q 08	8
PER 16Q 09	9
PER 16Q 10	10

ER20 precisa	
code	d 1
PER 20Q 01	1
PER 20Q 0150	1.5
PER 20Q 02	2
PER 20Q 0250	2.5
PER 20Q 03	3
PER 20Q 04	4
PER 20Q 05	5
PER 20Q 06	6
PER 20Q 07	7
PER 20Q 08	8
PER 20Q 09	9
PER 20Q 10	10
PER 20Q 11	11
PER 20Q 12	12
PER 20Q 13	13

Q = alta precisione - high precision

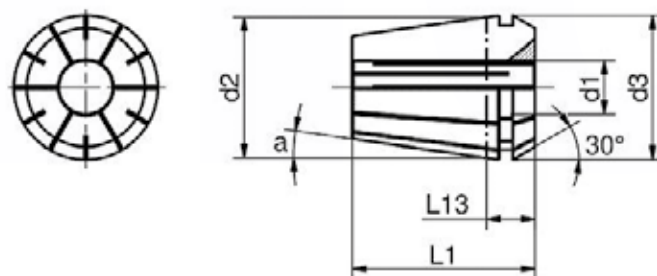

PER Q

ER25 precisa	
code	d 1
PER 25Q 01	1
PER 25Q 0150	1.5
PER 25Q 02	2
PER 25Q 0250	2.5
PER 25Q 03	3
PER 25Q 04	4
PER 25Q 05	5
PER 25Q 06	6
PER 25Q 07	7
PER 25Q 08	8
PER 25Q 09	9
PER 25Q 10	10
PER 25Q 11	11
PER 25Q 12	12
PER 25Q 13	13
PER 25Q 14	14
PER 25Q 15	15
PER 25Q 16	16

ER32 precisa	
code	d 1
PER 32Q 02	2
PER 32Q 0250	2.5
PER 32Q 03	3
PER 32Q 04	4
PER 32Q 05	5
PER 32Q 06	6
PER 32Q 07	7
PER 32Q 08	8
PER 32Q 09	9
PER 32Q 10	10
PER 32Q 11	11
PER 32Q 12	12
PER 32Q 13	13
PER 32Q 14	14
PER 32Q 15	15
PER 32Q 16	16
PER 32Q 17	17
PER 32Q 18	18
PER 32Q 19	19
PER 32Q 20	20

ER40 precisa	
code	d 1
PER 40Q 04	4
PER 40Q 05	5
PER 40Q 06	6
PER 40Q 07	7
PER 40Q 08	8
PER 40Q 09	9
PER 40Q 10	10
PER 40Q 11	11
PER 40Q 12	12
PER 40Q 13	13
PER 40Q 14	14
PER 40Q 15	15
PER 40Q 16	16
PER 40Q 17	17
PER 40Q 18	18
PER 40Q 19	19
PER 40Q 20	20
PER 40Q 21	21
PER 40Q 22	22
PER 40Q 23	23
PER 40Q 24	24
PER 40Q 25	25
PER 40Q 26	26

Q = alta precisione - high precision

PER Q BAG

Valigetta per pinze DIN 6499 di alta qualità

Bag high quality collets DIN 6499



Valigetta per pinze DIN 6499 di alta qualità

- Valigetta con serie Pinze tipo - ER DIN 6499 di Qualità
- RUN OUT 5 μ m
- Alta resistenza alla corrosione

Bag High Quality Collets DIN 6499

- Bag with set of collets ER Type - Din 6499 di Qualità
- RUN OUT 5 μ m
- Enhanced resistance to corrosion

code	$\emptyset 1$	N° P.	APPLICATION
PER.11Q.BAG13.P	1 ÷ 7 x 0,5	13	ER 11 - BAG
PER.16Q.BAG10.P	1 ÷ 10 x 1,0	10	ER 16 - BAG
PER.20Q.BAG12.P	2 ÷ 13 x 1,0	12	ER 20 - BAG
PER.25Q.BAG15.P	2 ÷ 16 x 1,0	15	ER 25 - BAG
PER.32Q.BAG18.P	3 ÷ 20 x 1,0	18	ER 32 - BAG
PER.40Q.BAG23.P	4 ÷ 26 x 1,0	23	ER 40 - BAG

PER T

Pinza a tenuta vulcanizzata DIN 6499

Rubber sealed collet DIN 6499

Pince de serrage étanches vulcanisées DIN 6499

Spannzangen vulkanisiert für innenkuhlung DIN 6499

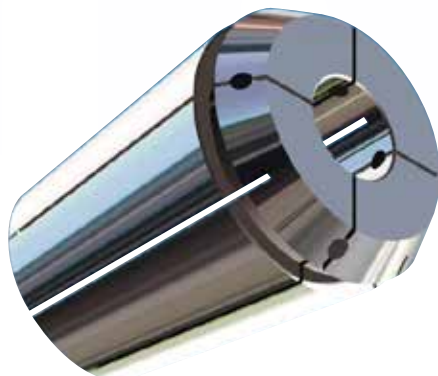

PINZE STANDARD DIN 6499 a tenuta del lubrorefrigerante

- RUN OUT 0,008
- MAX 25 bar
- La vulcanizzazione del taglio canalizza il refrigerante all'interno dell'utensile
- Bloccano solo diametro nominale degli utensili con gambo degli utensili con gambo toll. max - h10
- La tenuta è garantita solo per utensili con gambo uguale al diametro nominale della pinza e inseriti per tutta la sua lunghezza di presa.

STANDARD COLLETS DIN 6499 for inner coolant supply

- RUN OUT 0,008
- MAX 25 bar
- Vulcanization canalizes the cooling system inside the tool
- Nominale clamping diameter only.
Tool shank tolerance max - h10
No clamping range
- Sealing is guaranteed only for tools with nominal diameter of collet inserted for total length of bore.

ER16	
code	d 1
PER.16T.03	3
PER.16T.04	4
PER.16T.05	5
PER.16T.06	6
PER.16T.07	7
PER.16T.08	8
PER.16T.09	9
PER.16T.10	10

ER20	
code	d 1
PER.20T.03	3
PER.20T.04	4
PER.20T.05	5
PER.20T.06	6
PER.20T.07	7
PER.20T.08	8
PER.20T.09	9
PER.20T.10	10
PER.20T.11	11
PER.20T.12	12
PER.20T.13	13

T = pinza a tenuta - sealed collet

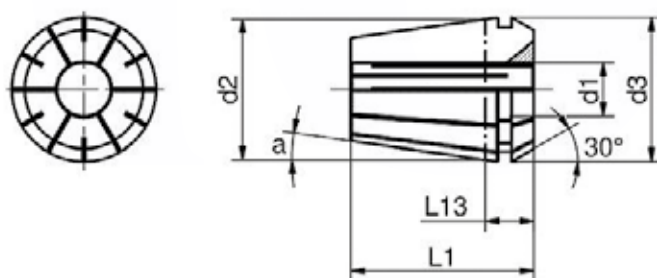

PER T

ER25	
code	d 1
PER.25T.03	3
PER.25T.04	4
PER.25T.05	5
PER.25T.06	6
PER.25T.07	7
PER.25T.08	8
PER.25T.09	9
PER.25T.10	10
PER.25T.11	11
PER.25T.12	12
PER.25T.13	13
PER.25T.14	14
PER.25T.15	15
PER.25T.16	16

ER32	
code	d 1
PER.32T.03	3
PER.32T.04	4
PER.32T.05	5
PER.32T.06	6
PER.32T.07	7
PER.32T.08	8
PER.32T.09	9
PER.32T.10	10
PER.32T.11	11
PER.32T.12	12
PER.32T.13	13
PER.32T.14	14
PER.32T.15	15
PER.32T.16	16
PER.32T.17	17
PER.32T.18	18
PER.32T.19	19
PER.32T.20	20

ER40	
code	d 1
PER.40T.03	3
PER.40T.04	4
PER.40T.05	5
PER.40T.06	6
PER.40T.07	7
PER.40T.08	8
PER.40T.09	9
PER.40T.10	10
PER.40T.11	11
PER.40T.12	12
PER.40T.13	13
PER.40T.14	14
PER.40T.15	15
PER.40T.16	16
PER.40T.17	17
PER.40T.18	18
PER.40T.19	19
PER.40T.20	20
PER.40T.21	21
PER.40T.22	22
PER.40T.23	23
PER.40T.24	24
PER.40T.25	25
PER.40T.26	26

T = pinza a tenuta - sealed collet

PER TW

Pinze a tenuta con fori per refrigerante DIN 6499

Collets DIN 6499 - externally cooled collets

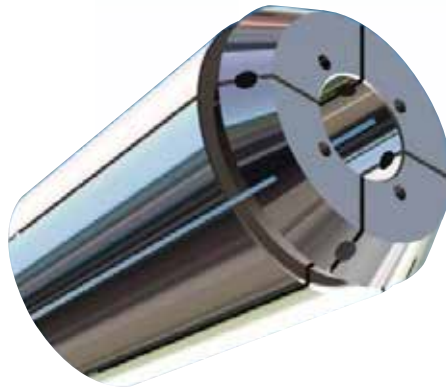

PINZE STANDARD DIN 6499

a tenuta con fori per lubrorefrigerante

- RUN OUT 0,008
- MAX 25 bar
- La vulcanizzazione del taglio canalizza il refrigerante all'interno dei fori sulla pinza permettendogli di raggiungere l'utensile
- Bloccano solo diametro nominale degli utensili con gambo toll. Max - h10
- La tenuta è garantita solo per utensili con gambo uguale al diametro nominale della pinza e inseriti per tutta la sua lunghezza di presa.

STANDARD COLLETS DIN 6499

externally cooled collets

- RUN OUT 0,008
- MAX 25 bar
- The vulcanization of the cut, channels the coolant inside the holes of the collet, allowing it to reach the tool
- Nominale clamping diameter only.
Tool shank tolerance Max - h10.
No clamping range
- Sealing is guaranteed only for tools with nominal diameter of collet inserted for total length of bore.

TW = pinze fori refrigerante - externally cooled collets

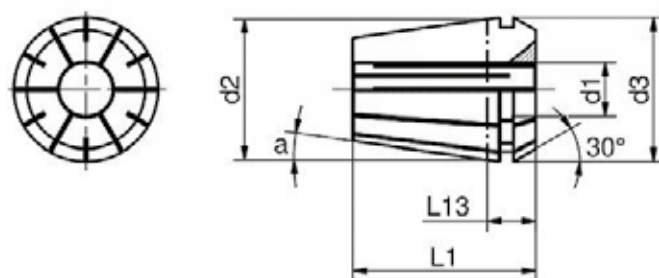

PER TW

ER16	
code	d 1
PER.16TW.03	3
PER.16TW.04	4
PER.16TW.05	5
PER.16TW.06	6
PER.16TW.07	7
PER.16TW.08	8

ER25	
code	d 1
PER.25TW.03	3
PER.25TW.04	4
PER.25TW.05	5
PER.25TW.06	6
PER.25TW.07	7
PER.25TW.08	8
PER.25TW.09	9
PER.25TW.10	10
PER.25TW.11	11
PER.25TW.12	12
PER.25TW.13	13
PER.25TW.14	14
PER.25TW.15	15

ER32	
code	d 1
PER.32TW.03	3
PER.32TW.04	4
PER.32TW.05	5
PER.32TW.06	6
PER.32TW.07	7
PER.32TW.08	8
PER.32TW.09	9
PER.32TW.10	10
PER.32TW.11	11
PER.32TW.12	12
PER.32TW.13	13
PER.32TW.14	14
PER.32TW.15	15
PER.32TW.16	16
PER.32TW.17	17
PER.32TW.18	18
PER.32TW.19	19
PER.32TW.20	20

TW = pinze fori refrigerante - externally cooled collets

PER TSS

Pinze a tenuta meccanica DIN 6499

Solid sealed collets DIN 6499



PINZE ISO 15488 (Din 6499) a tenuta meccanica del lubrorefrigerante

- RUN OUT 0,008
- MAX 120 bar
- La conformazione dei tagli garantiscono un'ottima rigidità ed una elevata precisione di concentricità
- Inoltre non consente al refrigerante di passare attraverso essi e lo canalizzano all'interno dell'utensile
- La massima pressione è garantita solo per utensili con gambo uguale al diametro nominale della pinza e con tolleranza h6 e inseriti per tutta la sua lunghezza di presa.

COLLETS ISO 15488 (Din 6499) solid sealed collets

- RUN OUT 0,008
- MAX 120 bar
- *The conformation of the cuts allows a better runout accuracy and repeatability and canalizes the cooling system inside the tool*
- *Sealing is guaranteed only for tools with nominal diameter of collet with tolerance h6 inserted for total length of bore. No clamping range.*

TSS = pinze a tenuta meccanica - Solid sealed collets

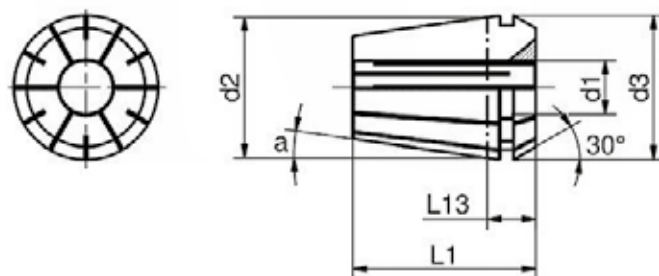

PER TSS

ER16	
code	d 1
PER.16TSS.03	3
PER.16TSS.04	4
PER.16TSS.05	5
PER.16TSS.06	6
PER.16TSS.07	7
PER.16TSS.08	8
PER.16TSS.09	9
PER.16TSS.10	10

ER25	
code	d 1
PER.25TSS.03	3
PER.25TSS.04	4
PER.25TSS.05	5
PER.25TSS.06	6
PER.25TSS.07	7
PER.25TSS.08	8
PER.25TSS.09	9
PER.25TSS.10	10
PER.25TSS.11	11
PER.25TSS.12	12
PER.25TSS.13	13
PER.25TSS.14	14
PER.25TSS.15	15
PER.25TSS.16	16

ER32	
code	d 1
PER.32TSS.03	3
PER.32TSS.04	4
PER.32TSS.05	5
PER.32TSS.06	6
PER.32TSS.07	7
PER.32TSS.08	8
PER.32TSS.09	9
PER.32TSS.10	10
PER.32TSS.11	11
PER.32TSS.12	12
PER.32TSS.13	13
PER.32TSS.14	14
PER.32TSS.15	15
PER.32TSS.16	16
PER.32TSS.17	17
PER.32TSS.18	18
PER.32TSS.19	19
PER.32TSS.20	20

TSS = pinze a tenuta meccanica - Solid sealed collets

PER M

Pinza portamaschi DIN 6499-AZ

Tap collets with internal square DIN 6499-AZ

Pince de serrage porte tarauds DIN 6499-AZ

Spannzangen Gewindebohreraufnahme DIN 6499-AZ

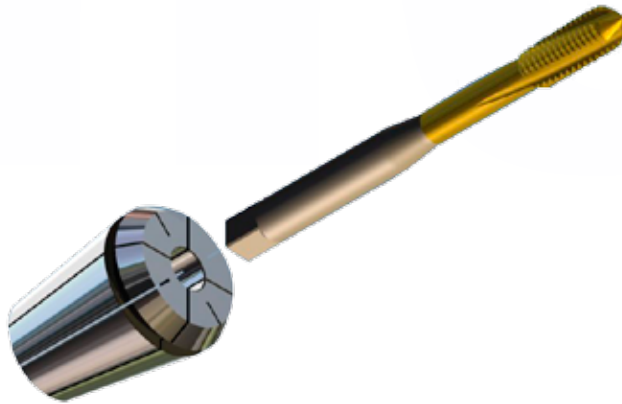

PINZE STANDARD DIN 6499

Portamaschi con quadro

- RUN OUT 0,015 mm
- Dotate di un quadro porta maschi
- I gambi dei maschi si riferiscono allo standard DIN 352 - 371 - 376 / ISO 529
- Bloccano solo diametro nominale degli utensili con gambo toll. Max - h10

STANDARD COLLETS DIN 6499

Tap collets with internal square

- RUN OUT 0,015 mm.
- Tapping collets with internal square
- Standard DIN 352- 371 - 376 / ISO 529
- Nominale clamping diameter only.
Tool shank tollerance
Max - h10. No clamping range.

M = pinza portamaschi - tap collet

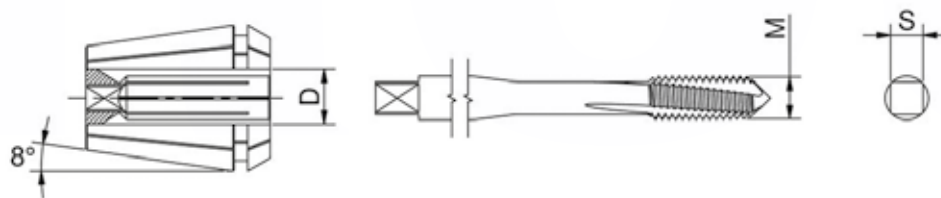

PER M

ER16				
code	D	S	DIN 371 M...	DIN 374/6 M...
PER 16M 03527	3.5	2.7	M.3	M.5
PER 16M 04030	4	3	M.3,5	-
PER 16M 04534	4.5	3.4	M.4	M.6
PER 16M 06049	6	4,9	M.5 M.6	M.8

ER25				
code	D	S	DIN 371 M...	DIN 374/6 M...
PER 25M 03527	3.5	2.7	M.3	M.5
PER 25M 04030	4	3	M.3,5	-
PER 25M 04534	4.5	3.4	M.4	M.6
PER 25M 06049	6	4,9	M.5 M.6	M.8
PER 25M 07055	7	5,5		M.10
PER 25M 08062	8	6.2	M.8	-
PER 25M 09070	9	7	-	M.12
PER 25M 10080	10	8	M.10	-
PER 25M 11090	11	9	-	M.14
PER 25M 12090	12	9	-	M.16

ER32				
code	D	S	DIN 371 M...	DIN 374/6 M...
PER 32M 04534	4.5	3.4	M.4	M.6
PER 32M 06049	6	4,9	M.5 M.6	M.8
PER 32M 07055	7	5,5		M.10
PER 32M 08062	8	6,2	M.8	-
PER 32M 09070	9	7	-	M.12
PER 32M 10080	10	8	M.10	-
PER 32M 11090	11	9	-	M.14
PER 32M 12090	12	9	-	M.16
PER 32M 14110	14	11	-	M.18
PER 32M 16120	16	12	-	M.20
PER.32M.16125	16	12,5	-	M.20

M = pinza portamaschi - tap collet

PER MT

Pinza DIN 6499 portamaschi con quadro a tenuta del refrigerante

Sealed tap collets DIN 6499 with internal square

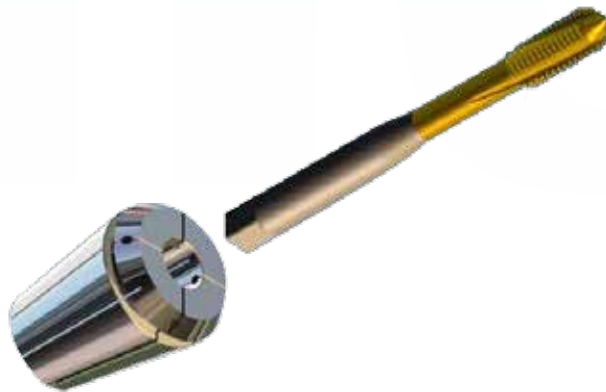

PINZE STANDARD DIN 6499 PORTAMASCHI con quadro a tenuta del refrigerante

- RUN OUT 0,015 mm
- MAX 25 bar
- Dotate di un quadro porta maschi
- La vulcanizzazione del taglio canalizza il refrigerante all'interno dell'utensile
- I gambi dei maschi si riferiscono allo Standard DIN 352 - 371 - 376 / ISO 529
- Bloccano solo diametro nominale degli utensili con gambo toll. Max - h10.
- La tenuta è garantita solo per utensili con gambo uguale al diametro nominale della pinza e inseriti per tutta la sua lunghezza di presa.

STANDARD COLLETS DIN 6499 SEALED TAP COLLETS with internal square

- RUN OUT 0,015 mm
- MAX 25 bar
- Tapping collets with internal square
- Vulcanization canalizes the cooling system inside the tool Standard DIN 352 - 371 - 376 / ISO 529
- Nominale clamping diameter only. Tool shank tolerance Max - h10. No clamping range
- Sealing is guaranteed only for tools with nominal diameter of collet inserted for total length of bore.

MT = pinza portamaschi - tap collet

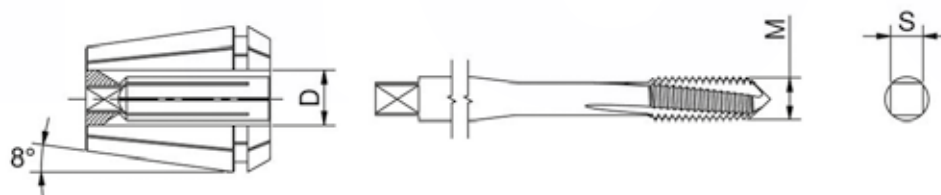

PER MT

ER16				
code	D	S	DIN 371 M...	DIN 374/6 M...
PER 16MT 03527	3.5	2.7	M.3	M.5
PER 16MT 04030	4	3	M.3,5	-
PER 16MT 04534	4.5	3.4	M.4	M.6
PER.16MT.05040	5	4		M.7
PER.16MT.06049	6	4,9	M.5 M.6	M.8
PER.16MT.07055	7	5,5		M.10
PER.16MT.08062	8	6,2	M.8	

ER25				
code	D	S	DIN 371 M...	DIN 374/6 M...
PER 25MT 03527	3.5	2.7	M.3	M.5
PER 25MT 04030	4	3	M.3,5	-
PER 25MT 04534	4.5	3.4	M.4	M.6
PER.25MT.05040	5	4		M.7
PER.25MT.06049	6	4,9	M.5 M.6	M.8
PER 25MT 07055	7	5,5		M.10
PER 25MT 08062	8	6,2	M.8	-
PER 25MT 09070	9	7	-	M.12
PER 25MT 10080	10	8	M.10	-
PER 25MT 11090	11	9	-	M.14
PER 25MT 12090	12	9	-	M.16
PER.25MT.125100	12,5	10		M.16
PER.25MT.14110	14	11		M.18
PER.25MT.16120	16	12		M.20

ER32				
code	D	S	DIN 371 M...	DIN 374/6 M...
PER.32MT.03527	3.5	2.7	M.3	M.5
PER.32MT.04534	4.5	3.4	M.4	M.6
PER.32MT.05040	5	4		M.7
PER 32MT 06049	6	4,9	M.5 M.6	M.8
PER 32MT 07055	7	5,5		M.10
PER 32MT 08062	8	6,2	M.8	-
PER 32MT 09070	9	7	-	M.12
PER 32MT 10080	10	8	M.10	-
PER 32MT 11090	11	9	-	M.14
PER 32MT 12090	12	9	-	M.16
PER.32MT.125100	12.5	10		M.16
PER.32MT.14110	14	11		M.18
PER.32MT.16120	16	12		M.20
PER.32MT.18145	18	14.5		M.22 M.24
PER.32MT.20016	20	16		M.27

MT = pinza portamaschi - tap collet

GHIERE-Clamping nuts

ISO 15488 (Din 6499)



RGM - DIN 6499

Ghiera mini ISO 15488 (Din 6499)
Mini clamping nuts DIN 6499

p. 338

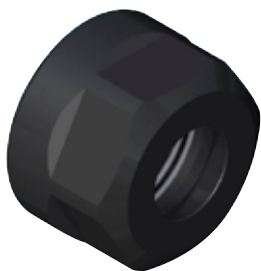

RGX

Ghiera esagonale DIN 6499
Exagonal clamping nuts DIN 6499

p. 339



RGX...E

Ghiera pre-balanced esagonale DIN 6499
Exagonal pre-balanced clamping nuts DIN 6499

p. 339

RGS - standard

Ghiera standard DIN 6499

Standard clamping nuts DIN 6499

p. 340



RGE

Ghiera pre-balanced DIN 6499

Pre-balanced clamping nuts DIN 6499

p. 341



Dati tecnici ed immagini sono indicativi. Mickros si riserva di apportare aggiornamenti in qualsiasi momento e senza obbligo di preavviso.
Technical data and drawings are for information purposes only. Mickros reserves the right to update specs at anytime and without notice.

RGM - ISO 15488 (Din 6499)

Ghiera mini DIN 6499

Mini clamping nuts DIN 6499

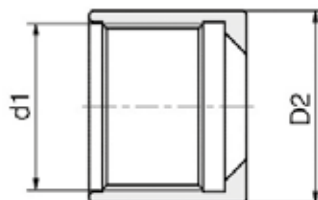

GHIERA ECCENTRICA MINI - DX
per pinze ER DIN 6499

ECCENTRIC MINI CLAMPING NUTS - RIGHT
for collets ER DIN 6499

code	d1 - M	D2	chiave - wrench
RGM ER11	M.13x0,75	16	ACH GM11
RGM ER16	M.19x1	22	ACH GM16
RGM ER20	M.24x1	28	ACH GM20
RGM ER25	M.30x1	35	ACH GM25

Accessori | Accessories

Ricambi | Spare parts

ACH GM



p. 344

RGX / RGX...E

Ghiera esagonale DIN 6499

Exagonal clamping nuts DIN 6499

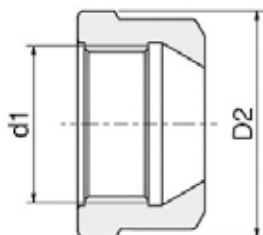

RGX

GHIERA ECCENTRICA ESAGONALE - DX
per pinze ER DIN 6499

ECCENTRIC EXAGONAL CLAMPING NUTS - RIGHT
for collets ER DIN 6499

RGX...E pre-balanced

GHIERA ECCENTRICA ESAGONALE - DX
per pinze ER DIN 6499

ECCENTRIC EXAGONAL CLAMPING NUTS - RIGHT
for collets ER DIN 6499

code RGX	code RGX...E	d1 - M	D2	SW	chiave - wrench
RGX ER11	RGX. ER11E	M.14x0,75	19	17	ACH GX11
RGX ER16	RGX. ER16E	M.22x1,5	28	25	ACH GX16
RGX ER20	RGX. ER20E	M.25x1,5	34	30	ACH GX20

Accessori | Accessories

ACH GX



p. 344

Ricambi | Spare parts

RGS - standard

Ghiera standard DIN 6499

Standard clamping nuts DIN 6499

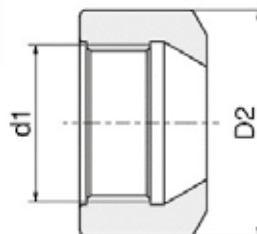

GHIERA ECCENTRICA STANDARD - DX
secondo ISO 15488 / DIN 6499
per pinze ER DIN 6499

ECCENTRIC STANDARD - RIGHT
according to ISO 15488 / DIN 6499
for collets ER DIN 6499

code	d1 - M	D2	chiave - wrench
RGS ER16	M.22x1,5	32	ACH GS16
RGS ER20	M.25x1,5	35	ACH GS20
RGS ER25	M.32x1,5	42	ACH GS25
RGS ER32	M.40x1,5	50	ACH GS32
RGS ER40	M.50x1,5	63	ACH GS40

Accessori | Accessories

Ricambi | Spare parts

ACH GS



p. 344

RGE

Ghiera pre-balanced DIN 6499

Pre-balanced clamping nuts DIN 6499

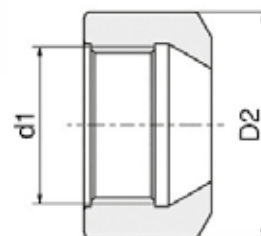

GHIERA DI PRECISIONE ECCENTRICA - DX
PRE-BALANCED
per pinze ER DIN 6499

PRECISION ECCENTRIC CLAMPING NUTS - RIGHT
PRE-BALANCED
for collets ER DIN 6499

code	d1 - M	D2	chiave - wrench
RGE ER16	M.22x1,5	32	ACH GS16
RGE ER20	M.25x1,5	35	ACH GS20
RGE ER25	M.32x1,5	42	ACH GS25
RGE ER32	M.40x1,5	50	ACH GS32
RGE ER40	M.50x1,5	63	ACH GS40

Accessori | Accessories

Ricambi | Spare parts

ACH GS



p. 344

Chiavi Wrenches

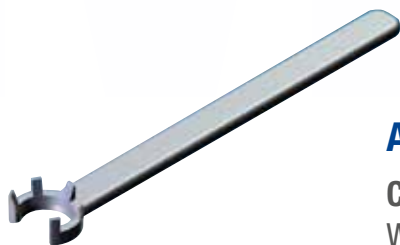

ACH GM

Chiave di serraggio per ghiera mini
Wrench for mini nut

p. 344



ACH GS

Chiave di serraggio per ghiera Standard
Wrench for standard nut

p. 344



ACH GX

chiave di serraggio per ghiera Esagonali
Wrench for Exagonal nut

p. 344

ACD NM

Chiave dinamometrica
Dynamometric Wrench

p. 345



ACD GE

Inserto chiave dinamometrica per ghiera RGS-RGE
Interchangeable head for RGS-RGE nuts

p. 345

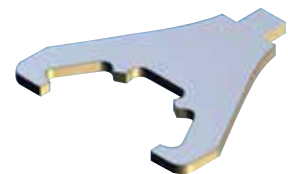

ACD RA

Rinvio angolare con inserto esagonale
Angle drive for torque wrench

p. 345



ACD ES

Inserto esagonale serraggio weldon e pu
Hexagonal insert

p. 345



Dati tecnici ed immagini sono indicativi. Mickros si riserva di apportare aggiornamenti in qualsiasi momento e senza obbligo di preavviso.
Technical data and drawings are for information purposes only. Mickros reserves the right to update specs at anytime and without notice.

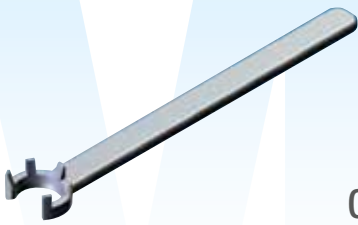

ACH GM

CHIAVE DI SERRAGGIO PER GHIERE MINI
WRENCH FOR MINI NUT

codice - code	APPLICATION
ACH.GM11	RGM.ER11
ACH.GM16	RGM.ER16
ACH.GM20	RGM.ER20
ACH.GM25	RGM.ER25



ACH GS

CHIAVE DI SERRAGGIO PER GHIERE STANDARD RGS-RGE
WRENCH FOR STANDARD RGS-RGE NUTS

codice - code	APPLICATION
ACH.GS16	RGS-RGE ER16
ACH.GS20	RGS-RGE ER20
ACH.GS25	RGS-RGE ER25
ACH.GS32	RGS-RGE ER32
ACH.GS40	RGS-RGE ER40



ACH GX

CHIAVE DI SERRAGGIO PER GHIERE ESAGONALI
WRENCH FOR EXAGONAL NUT

codice - code	SW	APPLICATION
ACH.GX11	SW 17	RGX.ER11
ACH.GX16	SW 25	RGX.ER16
ACH.GX20	SW 30	RGX.ER20

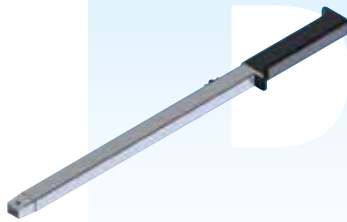

ACD NM

CHIAVE DINAMOMETRICA
DYNAMOMETRIC WRENCH

codice - code	Attacco-Drive	APPLICATION
ACD.090.NM010.050	9 x 12	F= 10÷50 Nm
ACD.140.NM040.200	14 x 18	F= 40÷200 Nm

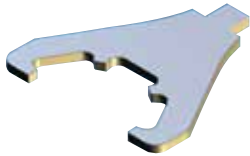

ACD GE

INSERTO CHIAVE DINAMOMETRICA PER GHIERE RGS-RGE
INTERCHANGEABLE HEAD FOR RGS-RGE NUTS

codice - code	Attacco-Drive	APPLICATION
ACD.140.GE16	14 x 18	RGS-RGE ER16 (F=50÷70Nm)
ACD.140.GE20	14 x 18	RGS-RGE ER20 (F=70÷90Nm)
ACD.140.GE25	14 x 18	RGS-RGE ER25 (F=80÷100Nm)
ACD.140.GE32	14 x 18	RGS-RGE ER32 (F=90÷110Nm)
ACD.140.GE40	14 x 18	RGS-RGE ER40 (F=100÷140Nm)



ACD RA

RINVIO ANGOLARE CON INSERTO ESAGONALE
ANGLE DRIVE FOR TORQUE WRENCH

codice - code	Attacco-Drive	APPLICATION
ACD.090.RA014	9x12 1/4"	ACD.090.NM010.050
ACD.090.RA012	9x12 1/2"	ACD.090.NM010.050



ACD ES

INSERTO ESAGONALE SERRAGGIO WELDON E PU
HEXAGONAL INSERT

codice - code	Attacco-Drive	APPLICATION
ACD.014.ES03	1/4"-ch.3	WE 06 (ACD.090.RA014)
ACD.012.ES04	1/2"-ch.4	WE 08 (ACD.090.RA012)
ACD.012.ES05	1/2"-ch.5	WE 10 / PU 14÷25 (ACD.090.RA012)
ACD.012.ES06	1/2"-ch.6	WE 12÷18 / PU 32 (ACD.090.RA012)
ACD.012.ES08	1/2"-ch.8	WE 20 / PU 40÷50 (ACD.090.RA012)
ACD.012.ES10	1/2"-ch.10	WE 25÷40 (ACD.090.RA012)

ABM R/RW

Bussola portamaschi senza frizione

Tap-collet

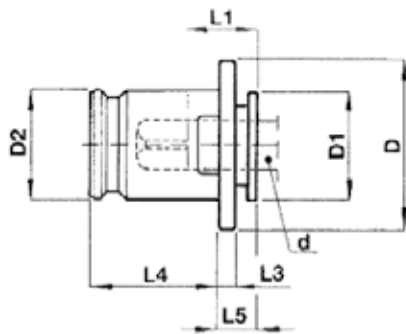

tipo R type

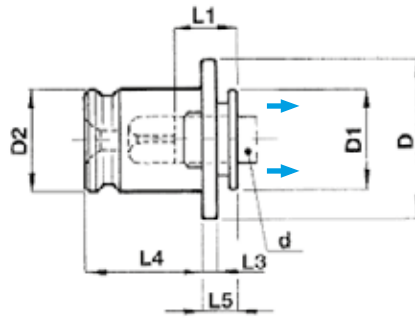

tipo RW type

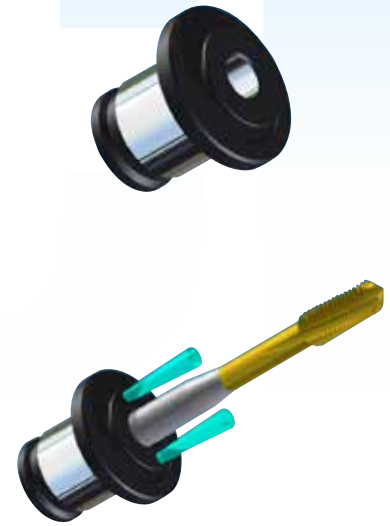

code	capacità capacity	diametro gambo maschio shank dia.	da utilizzare con to be used with	D2	D21	D22	L1	L3	L4	L5
ABM 19R....	M3 ÷ M14	Da 3,5 a 11,3	..MC019.. ..MR019..	30	19	19	17	4	21,5	7
ABM 31R....	M4 ÷ M24	Da 7 a 18	..MC031.. ..MR031..	48	30	31	30	5	35	11
ABM 48R....	M14 ÷ M36	Da 11 a 28	..MC048.. ..MR048..	70	48	48	44	6	55,5	14

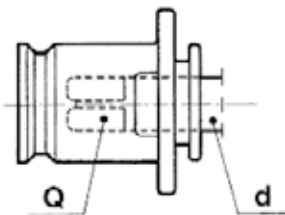

tipo R type

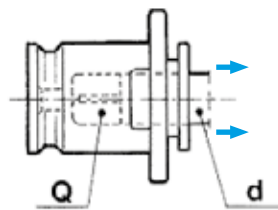

tipo RW type

code	d	Q
ABM 19R 02821	2,8	2,1
ABM 19R 03527	3,5	2,7
ABM 19R 04030	4,0	3,0
ABM 19R 04534	4,5	3,4
ABM 19R 06049	6,0	4,9
ABM 19R 07055	7,0	5,5
ABM 19R 08062	8,0	6,2
ABM 19R 09070	9,0	7,0
ABM 19R 10080	10	8,0
ABM 19R 11090	11	9,0
ABM 19R 06049 W	6,0	4,9
ABM 19R 07055 W	7	5,5
ABM 19R 08062 W	8,0	6,2
ABM 19R 09070 W	9,0	7,0
ABM 19R 10080 W	10	8,0
ABM 19R 11090 W	11	9,0

code	d	Q
ABM 31R 06049	6,0	4,9
ABM 31R 07055	7,0	5,5
ABM 31R 08062	8,0	6,2
ABM 31R 09070	9,0	7,0
ABM 31R 10080	10	8,0
ABM 31R 11090	11	9,0
ABM 31R 12090	12	9,0
ABM 31R 14110	14	10
ABM 31R 16120	16	12
ABM 31R 18145	18	14,5
ABM 31R 20160 .K	20	16
ABM 31R 22180 .K	22	18
ABM 31R 09070 W	9,0	7,0
ABM 31R 11090 W	11	9,0
ABM 31R 12090 W	12	9,0
ABM 31R 14110 W	14	10
ABM 31R 16120 W	16	12

code	d	Q
ABM 48R 11090	11	9,0
ABM 48R 12090	12	9,0
ABM 48R 14110	14	10
ABM 48R 16120	16	12
ABM 48R 18145	18	14,5
ABM 48R 20160	20	16
ABM 48R 22180	22	18
ABM 48R 25200	25	20
ABM 48R 28220	28	22
ABM 48R 32240 .K	32	24
ABM 48R 36290 .K	36	29
ABM 48R 18145 W	18	14,5
ABM 48R 20160 W	20	16
ABM 48R 22180 W	22	18
ABM 48R 25200 W	25	20

ABM F

Bussola portamaschi con frizione

Tap-collet with overload clutch

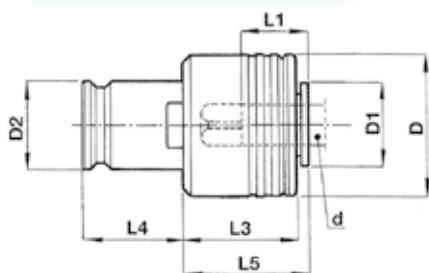

codice code	capacità capacity	diametro gambo maschio shank dia.	da utilizzare con to be used with	D2	D21	D22	L1	L3	L4	L5
ABM 19F...	M3 ÷ M14	Da 3,5 a 11,3	..MC019..	32	19	19	17	25	21,5	25
ABM 31F...	M4 ÷ M24	Da 7 a 18	..MC031..	50	30	31	30	31	35	34
ABM 48F...	M14 ÷ M36	Da 11 a 28	..MC048..	72	48	48	44	41	55,5	45

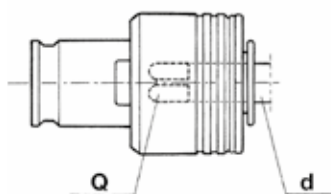

code	d	Q	DIN
ABM 19F 02821 M2 (3/32")	2,8	2,1	371
ABM 19F 03527 M3 (1/8")	3,5	2,7	371
ABM 19F 04030 M35	4,0	3,0	371
ABM 19F 04534 M4 (5/32")	4,5	3,4	371
ABM 19F 04534 M6 (1/4")	4,5	3,4	374 376
ABM 19F 05543 M7	5,5	4,3	376
ABM 19F 06049 M5	6,0	4,9	371
ABM 19F 06049 M6	6,0	4,9	371
ABM 19F 06049 M8	6,0	4,9	374 376
ABM 19F 07055 M10 (3/8"-G1/8")	7,0	5,5	374 376
ABM 19F 08062 M8 (5/16")	8,0	6,2	371
ABM 19F 09070 M12 (1/2")	9,0	7,0	374 376
ABM 19F 10080 M10	10	8,0	371
ABM 19F 11090 M14 (9/16"-G1/4")	11	9,0	374 376
ABM 19F 1209 M16 (5/8"-G3/8")	12	9,0	374 376

code	d	Q	DIN
ABM 31F 06049 M6	6,0	4,9	352 371
ABM 31F 06049 M8	6,0	4,9	374 376
ABM 31F 07055 M10 (3/8"-G1/8")	7,0	5,5	374 376
ABM 31F 08062 M8 (5/16")	8,0	6,2	371
ABM 31F 09070 M12 (1/2")	9,0	7,0	374 376
ABM 31F 10080 M10	10	8,0	371
ABM 31F 11090 M14 (9/16"-G1/4")	11	9,0	374 376
ABM 31F 12090 M16 (5/8"-G3/8")	12	9,0	374 376
ABM 31F 14110 M18 (11/16")	14	10	374 376
ABM 31F 16120 M20 (13/16"-G1/2")	16	12	374 376
ABM 31F 18145 M22 (7/8"-G5/8")	18	14,5	374 376
ABM 31F 18145 M24 (15/16")	18	14,5	374 376

code	d	Q	DIN
ABM 48F 09070 M12	9	7,0	374 376
ABM 48F 11090 M14	11	9,0	374 376
ABM 48F 12090 M16 (5/8"-G3/8")	12	9,0	374 376
ABM 48F 14110 M18 (11/16")	14	10	374 376
ABM 48F 16120 M20 (13/16"-G1/2")	16	12	374 376
ABM 48F 18145 M22 (7/8"-G5/8")	18	14,5	374 376
ABM 48F 18145 M24 (15/16")	18	14,5	374 376
ABM 48F 20160 M27 (1"-G3/4")	20	16	374 376
ABM 48F 22180 M30 (1 1/8"-G7/8")	22	18	374 376
ABM 48F 25200 M33 (1 1/4"-G 1")	25	20	374 376

Dimensioni gambi maschi DIN

Tap shank dimensions to DIN

Dimensione Dimension Ø x	DIN 352	DIN 353	DIN 371	DIN 374	DIN 376	DIN 2182	DIN 2183
2,5 x 2,1	M 1	-	M 1	-	M 3,5	1/16"	-
	M 1,1	-	M 1,1	M 3,5	-	-	-
	M 1,2	-	M 1,2	-	-	-	-
	M 1,4	-	M 1,4	-	-	-	-
	M 1,6	-	M 1,6	-	-	-	-
	M 1,8	-	M 1,8	-	-	-	-
2,8 x 2,1	M 2	-	M 2	M 4	M 4	3/32"	5/32"
	M 2,2	-	M 2,2	-	-	-	-
	M 2,5	-	M 2,5	-	-	-	-
3,5 x 2,7	M 3	-	M 3	M 5	M 5	1/8"	-
4 x 3	M 3,5	-	M 3,5	-	-	-	-
4,5 x 3,4	M 4	-	M 4	M 6	M 6	5/32"	1/4"
	M 5	-	M 5	-	-	7/32"	-
	M 6	-	M 6	-	-	-	-
6 x 4,9	M 8	-	-	M 8	M 8	-	-
	M 10	G 1/8"	-	M 10	M 10	1/4"	3/8"
	M 12	-	-	M 12	M 12	3/8"	1/2"
10 x 8	-	-	M 10	-	-	-	-
11 x 9	M 14	G 1/4"	-	M 14	M 14	-	9/16"
12 x 9	M 16	G 3/8"	-	M 16	M 16	-	5/8"
14 x 11	M 18	-	-	M 18	M 18	-	11/16"
16 x 12	M 20	G 1/2"	-	M 20	M 20	-	13/16"
18 x 14,5	M 22	G 5/8"	-	M 22	M 22	-	7/8"
	M 24	-	-	M 24	M 24	-	15/16"
20 x 16	M 27	G 3/4"	-	M 27	M 27	-	1"
22 x 18	M 30	G 7/8"	-	M 30	M 30	-	1.1/8"
25 x 20	M 33	G 1"	-	M 33	M 33	-	1.1/4"
28 x 22	M 36	G 1.1/8"	-	M 36	M 36	-	1.3/8"
32 x 24	M 39	G 1.1/4"	-	M 39	M 39	-	1.1/2"
	M 42	-	-	M 42	M 42	-	1.5/8"
	M 45	G 1.3/8"	-	M 45	M 45	-	1.3/4"
36 x 29	M 48	G 1.1/2"	-	M 48	M 48	-	1.7/8"
	-	G 1.3/4"	-	-	-	-	-
	-	G 2"	-	-	-	-	-
40 x 32	M 52	G 2.1/4"	-	M 52	M 52	-	2"
45 x 35	M 56	G 2.1/2"	-	-	M 56	-	2.1/4"
	M 60	-	-	-	M 60	-	-
50 x 39	M 64	G 2.3/4"	-	-	M 64	-	2.1/2"
	-	G 3"	-	-	-	-	-
56 x 44	M 68	G 3.1/4"	-	-	M 68	-	2.3/4"
	-	-	-	-	-	-	3"

ABR

Boccole di riduzione
Toolholder Bushing

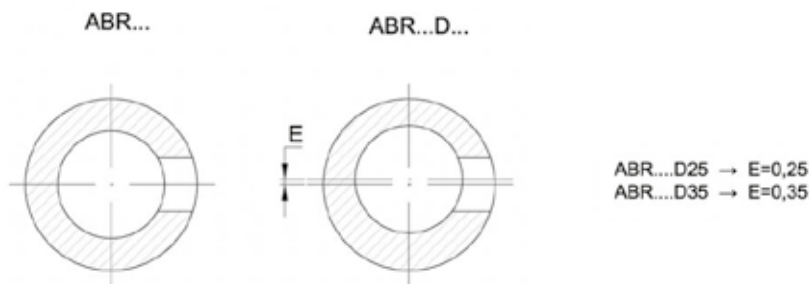

- Da utilizzare preferibilmente con mandrini portapunte PU - PUH DIN 6595 / 6535 HE

- Suitable to use with adapter for drilling tools PU - PUH DIN 6595 / 6535 HE

codice - code	$D_1 \Rightarrow d_2$	APPLICATION	ECCENTRIC
ABR.025.20	25 \Rightarrow 20	PU025	
ABR.032.16	32 \Rightarrow 16	PU032	
ABR.032.20	32 \Rightarrow 20	PU032	
ABR.040.16	40 \Rightarrow 16	PU040	
ABR.040.20	40 \Rightarrow 20	PU040	
ABR.040.25	40 \Rightarrow 25	PU040	
ABR.040.32D25*	40 \Rightarrow 32	PU040	E = 0,25
ABR.040.32D35*	40 \Rightarrow 32	PU040	E = 0,35
ABR.050.40D25*	50 \Rightarrow 40	PU050	E = 0,25
ABR.050.40D35*	50 \Rightarrow 40	PU050	E = 0,35

AVK WN

Kit per mandrini tipo WEH/WEW

Kit for tool holders WEH/WEW

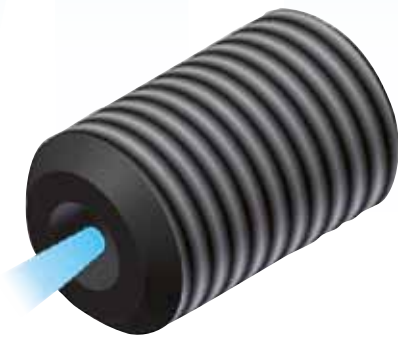

RVR

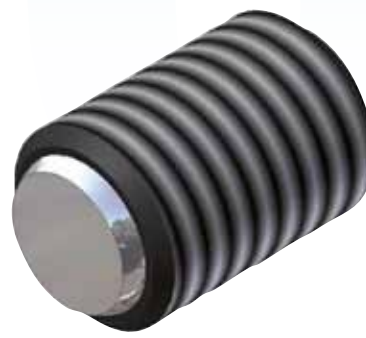

AVS

AVK WN

OPTIONAL KIT WHISTLE NOTCH DIN 6535 HE

- Vite speciale con sfera oscillante per il serraggio di utensili con piano inclinato 2° "AVSH WN..."
- Grano di battuta per la regolazione assiale dell'utensile "RVR..."

- Special screw with oscillating sphere for the tightening of tools with inclined layout 2° "AVSH WN".
- Sprig striking beat for axial regulation of the "RVR" tool

codice - code	APPLICATION
AVK.WN06	WE..06
AVK.WN08	WE..08
AVK.WN10	WE..10
AVK.WN12	WE..12

